

Superior Solutions for Industrial Heating and Ventilating



CONTENTS

4	Recognizing the Complexity of Industrial HVAC, Process Manufacturing, and Process Requirements
6	Why Dedicated HVAC Systems Are Better for Your Facility
8	Why HTHV Is Advantageous for Heating Industrial Facilities
10	Makeup Air Units Provide Proper Ventilation and Filtration Essential for IAQ and Safety
12	Integrated Controls Are Critical
14	ROI Analysis Illustrates a Fast Return
16	Why Cambridge Engineering
18	Our Process
20	Specifications



A photograph of an automotive assembly line. In the foreground, a silver car body is positioned on a yellow-painted floor. The car's hood is open, and its front end is partially disassembled. In the background, other car bodies are visible on the line, and the factory's complex metal structure and overhead lighting are prominent. A semi-transparent dark box is overlaid on the center of the image, containing white text.

When it comes to industrial facilities, we believe owners should not have to endure outdated and complicated Process Heating and HVAC systems. Retrofitting these with a distributed network of right-sized, right-located HVAC units and dedicated Process Heating systems can maximize energy efficiency, improve comfort, and lower maintenance costs.

Recognizing the Complexity of Industrial HVAC, Process Manufacturing, and Process Requirements

Industrial facilities today don't have to be new in order to be efficient

Leading facility owners and operators are retrofitting existing facilities into models of efficiency and sustainability. Industrial facility retrofits are investments in efficient technologies that span all facility systems, including lighting, facility envelope, and HVAC. While most facility owners still pursue single technology improvements, market leaders bundle together energy saving technologies in a more comprehensive approach to get deeper savings and greater lifecycle value.

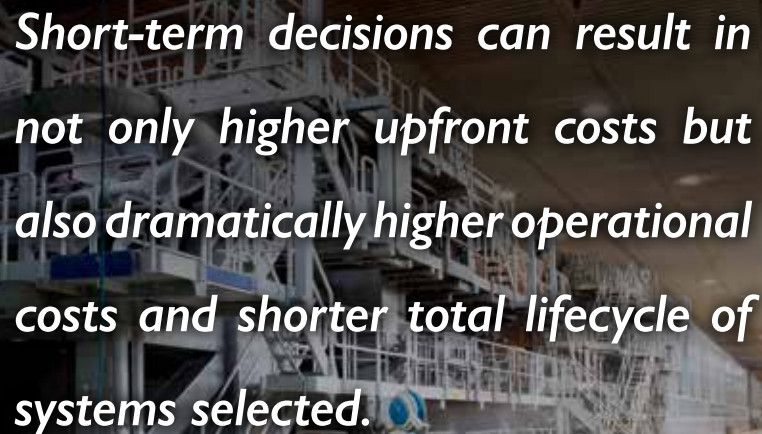

Short-term decisions can result in not only higher upfront costs but also dramatically higher operational costs and shorter total lifecycle of systems selected.

Challenges for facility leaders are complex

Facility leaders recognize that industrial retrofits are largely about managing risk.

Each facility project is unique and distinctive. Implementing a retrofit while protecting the production capabilities within the operation creates high visibility and requires a very clearly defined plan. Minimizing and eliminating all business interruption is always a top priority. It is also essential to protect the organization and meet or exceed all regulatory mandates to ensure safety for people. Facilities leaders seek trusted advisors and working arrangements that are in sync with all regulatory guidelines for facility compliance.

This complexity can result in a built-in resistance to efficiency retrofits and change. For this reason, facility retrofits are often conducted in a reactive versus a proactive mode. “Like-for-like” system replacements are the most expedient directive when reacting to a facility system failure or needed upgrade. However, with superior options available, these short-term decisions can result in not only higher upfront costs but also dramatically higher operational costs and shorter total lifecycle of systems selected.

Aging mechanical systems and equipment require asset-replacement planning

Various aging facilities systems drive more frequent routine maintenance and require more people resources to maintain, which increases operating cost. Aging facility assets are a reality. Planning for and developing a methodical aged asset replacement strategy requires leadership planning and trusted partner relationships in order to benefit from system expertise applicable to your unique facility requirements.



Systems interdependence impacts scalability

Industrial facilities evolve over time to reflect the changing needs of growing industries, modern equipment and processes, and other economic trends. In many instances, current production systems and technologies barely resemble their original form. Their supporting systems are often overlooked. As production systems change, there is a direct interdependence to process loads and exhaust systems. When HVAC systems are overlooked, this can cause inadequate makeup air, negative pressure problems, cold spots, and overall poor comfort levels.

Furthermore the infrastructures of these aged industrial facilities typically resemble single systems that serve multiple functions, thus hindering their ability to scale their production rapidly and efficiently. Facility leaders are left with difficult decisions when incremental changes in production capacity become less cost-effective because of inadequate, interdependent systems.

Facility leaders have many reasons to seek functional expertise and consultation to build proactive plans:

- To meet or exceed corporate energy reduction mandates
- To exceed production capacity metrics
- To provide labor with ideal environment conditions: people comfort, productivity, and facility thermal condition requirements
- To meet all facility safety regulations

Facility HVAC systems support improved process and production capacity

Facility leaders considering industrial retrofits of HVAC systems recognize the value of:

- Rapid ROI – multi-level corporate approvals
- System reliability and durability
- Lifecycle cost
- Standardization for proactive management and metrics
- Integration with building automation systems
- Complementing production and process applications of HVAC systems

Why Dedicated HVAC Systems Are Better for Your Facility

For the facility's unique processes and requirements, your team has designed and optimized every aspect of your operation. This optimization has become a minimum requirement for continued operation. But utilities and your HVAC systems are often thought of as ancillary systems. They become outdated and even neglected, despite this optimization of processes.

For facility leaders, minimizing or eliminating any process interruption is always top of mind. And you must ensure that regulatory and safety requirements are met at all times. As a result of these and other operational pressures, you probably undertake frequent routine maintenance if you have an aging facility system. For you, these aging systems with like-for-like replacement lead to increased labor investment, higher operational costs, and shorter total system lifecycle.



Production processes and technologies have changed

Many facilities' current boiler-driven process systems barely resemble their original design. Increasing the size of these systems to handle the heating requirements as well as the process loads added massive complexity and simply doesn't make sense today.

Instead of investing incrementally in an antiquated system, it is far more efficient financially and energy wise to take advantage of the dedicated system technology available today. Rather than continual reactive fixes, a proactive plan pays big dividends for the entire operation, from production efficiency, to air quality, comfort level, and more.

By retrofitting your existing heating, ventilating, and process steam systems with right-sized and right-located dedicated systems, you can:

- **Reduce energy costs**
- **Reduce maintenance costs**
- **Reduce operating costs**
- **Reduce asset replacement costs**
- **Reduce system complexity**

Dedicated space heating is better

Dedicated direct-fired High Temperature Heating & Ventilating technologies like the Cambridge S-Series can provide the most cost-effective way to meet comfort requirements year round. With 20% to 70% energy savings, flexible installation configuration, and minimum operations interruption, these dedicated systems can be used to solve a myriad of problems.

Dedicated makeup air is better

Dedicated direct-fired natural gas Outside Air Units (makeup air units) like the Cambridge M-Series provide extreme efficiency and effectiveness to solve complex building pressurization problems. Left unresolved, these pressure challenges could cause comfort, process, or indoor air quality problems. With full gas modulation and optional Variable Frequency Drives, the M-Series ranges from 1,800 CFM to 75,000 CFM and 454MBH to 6456MBH, meeting the toughest of ventilation requirements.

Once you have dedicated systems handling the space heating and ventilating loads, your team can concentrate on meeting the unique process needs with the most energy-efficient and code-compliant boiler. Additionally, since the process load has been isolated, you can run the boiler at a more consistent operating window, raising the efficiency even more. Minimizing the size of this unit significantly decreases maintenance cost and complexity with fewer steam traps, steam leaks, and miles of pipes to manage.

By embracing cutting-edge dedicated systems technology, facility leaders can spend less initially to purchase and install right-sized boiler systems. Additionally, you will realize ROI quickly with lower energy consumption and operating costs, as well as longer system lifecycle.

Why HTHV Is Advantageous for Heating Industrial Facilities

High Temperature Heating & Ventilating (HTHV) direct-fired 100% outside air technologies

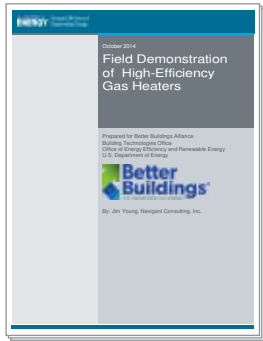

HTHV with High Velocity Blowers provides destratification. Temperature stratification is a major issue in all high-bay industrial applications in the wintertime and must be addressed through the proper selection of destratification technologies. A recent study published by the Department of Energy titled *Field Study of High Efficiency Gas Heaters* looked at the energy savings accomplished with HTHV 100% outside air direct-fired technologies. The report

states: "As evidenced by the temperature readings near the floor and ceiling, the new (Direct-fired 100% Outside Air HTHV) gas heaters reduced stratification, maintained more uniform temperature distribution, and consumed 20% less natural gas."

HTHV provides continuous or intermittent control options and heating and ventilating in a single unit

Direct-fired 100% outside air systems provide controls to operate either continuously or intermittently based on occupancy schedule, process conditions, pressure, or any number of other control requirements. There are actually three primary modes of operation for these HTHV 100% Outside Air Technologies:

- Ventilation/Exhaust Replenishment
- Space Heat & Ventilation
- Space Heat

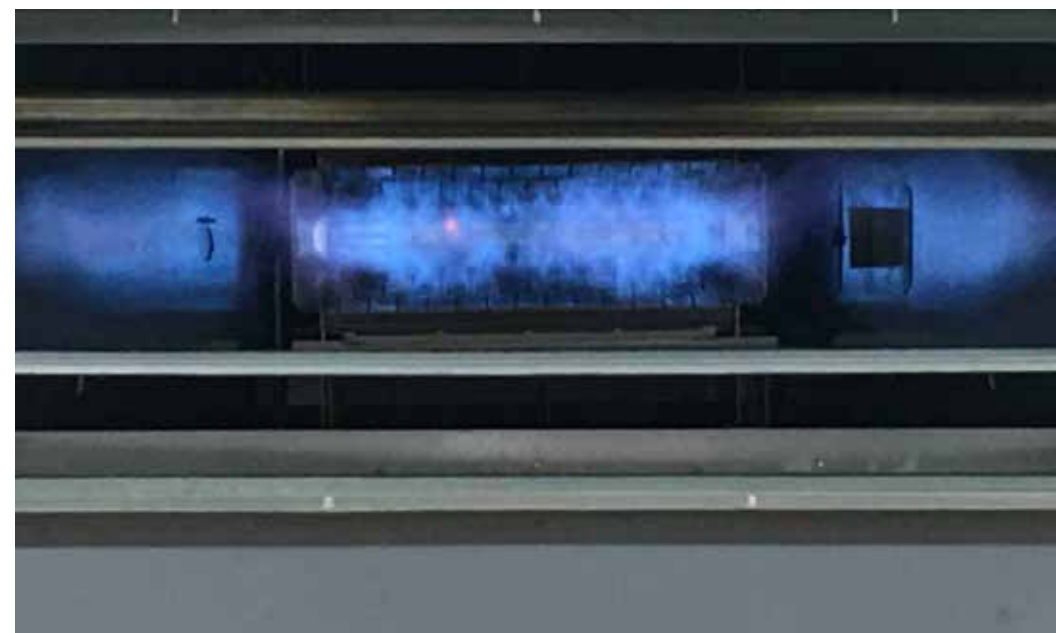

HTHV provides pressure control design flexibility

There are many different ways to pressure control a building. 100% outside air direct-fired technologies are completely capable of being controlled at positive, negative, or neutral pressure. There is significant debate on what is the “best” pressure control methodology for a building in the winter. Negative reduces risk of condensation, and positive decreases draftiness. However, both methods increase energy consumption over neutral.

The HTHV technologies have become the gold standard for energy-efficient industrial warehouse heating in North America over the past 20 years. These technologies are now being launched into the broader commercial heating and ventilating market because of their energy efficiency and low installed costs.

The 100% outdoor air introduced through ANSI Z83.4 technology is designed and installed to improve the indoor air and environmental quality of the facility. Any level of required ventilation, including ASHRAE 62.1 levels, can be achieved and maintained through these technologies. Many offerings include optional MERV13 filters added to the inlet air of this device, further improving indoor air quality. ANSI Z83.4 equipment can be installed with a minimum amount of ductwork, providing an efficient and cost-effective installation. Additionally, the technology can be installed indoors or outdoors or in horizontal or vertical configurations, permitting added flexibility while always providing 100% fresh outside air.

Our website cambridge-eng.com/irg is a great resource for additional research on specialized high-efficiency equipment.

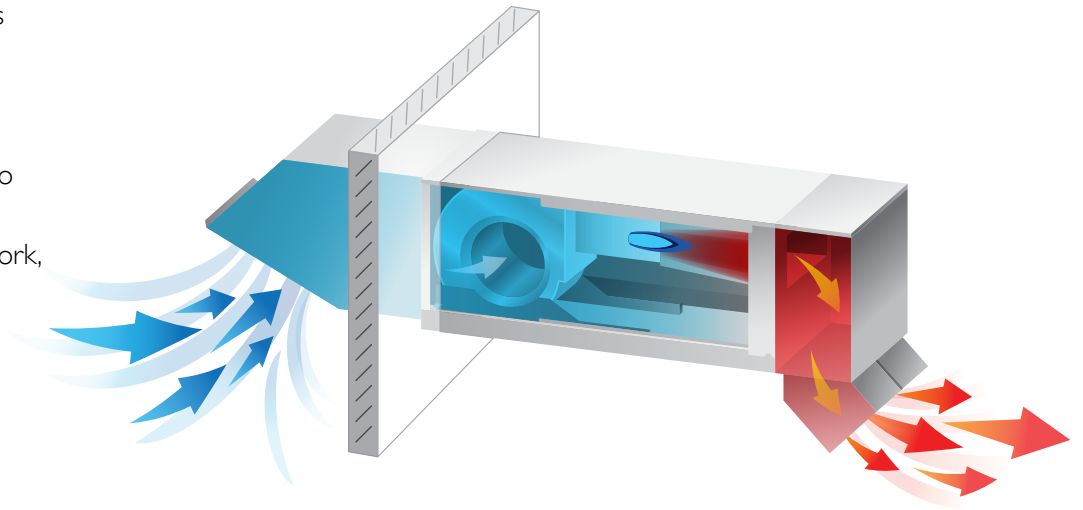

Makeup Air Units Provide Proper Ventilation and Filtration Essential for IAQ and Safety

Industrial facilities routinely use ventilation and filtration to ensure a healthy and safe working environment. Facility Engineers and Industrial Hygiene Engineers are tasked with protecting their employees from the harmful emissions of particles, gases, or microorganisms that can often be found in their facilities. In addition, these industrial sites have unique requirements for designing solutions that protect their sensitive manufacturing processes and components.

“Three fundamental measures will greatly reduce the likelihood of IAQ problems: good building and ventilation design, effective building maintenance (particularly of the HVAC system), and thoughtfully designed and executed renovation projects.”

Improving Indoor Air Quality at Work
American Industrial Hygiene Association (AIHA)

For these reasons, facility leaders often retrofit their facilities to employ an effective ventilation solution with the proper filtration requirements for unique applications... all while maximizing efficiency and operating costs.

Since safety can never be compromised in your facility, Cambridge Engineering provides multiple custom filtration solutions that can be engineered to meet your specifications and requirements.

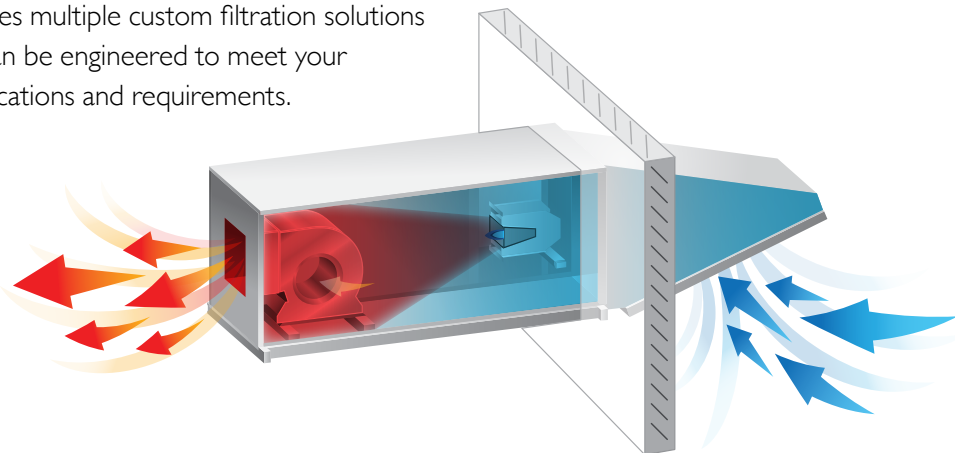



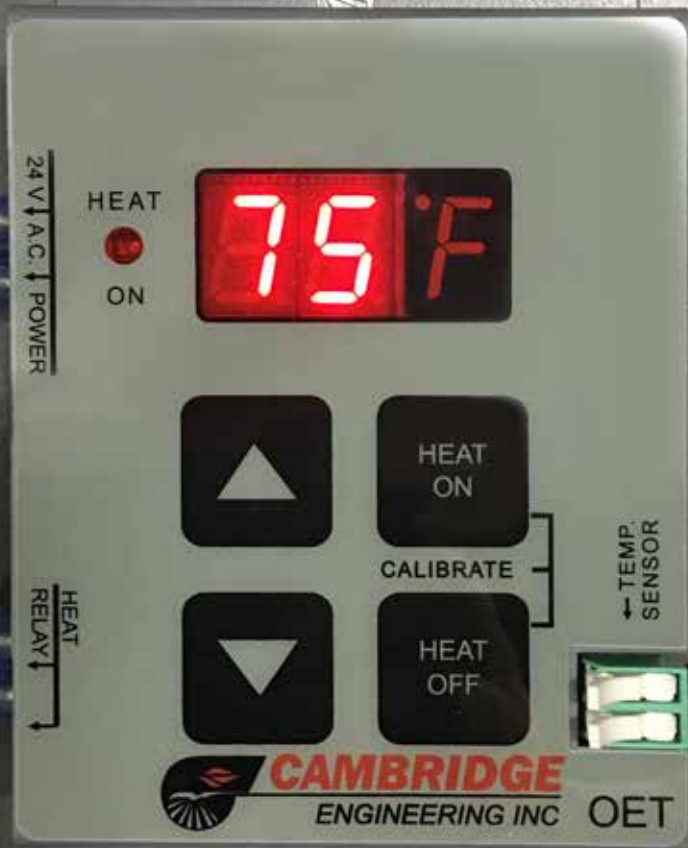

Integrated Controls Are Critical

Your team understands that no matter how well designed your HVAC systems are, they fall short of optimal efficiency without properly designed and deployed controls.

Cambridge Engineering offers several industrial control options ranging from simple and secure Industrial Remote Control Stations, to direct digital controls with BAS integration capabilities across multiple protocols (BACNet, LON, Modbus, etc.), to integrating your custom control packages. These control packages offer the ability to program heating and ventilating schedules with override capabilities to further fine-tune your processes and control sequences for maximum efficiency and comfort. All of these options allow for control and monitoring while continually maintaining the highest level of Burner Management on board for safety and reliability.

With full modulation capabilities for both gas and airflow and near limitless digital and analog inputs, your control options are infinite. Whether you are working to control temperature, pressure, ventilation, humidity, or some other key process variable, Cambridge's industrial M-Series and S-Series are the best choice for your facility.



ROI Analysis Illustrates a Fast Return

The exclusive capabilities of Cambridge Engineering products for your industrial retrofit provide multiple dedicated systems to meet your unique requirements, enabling you to maximize your return on investment. The utilization of dedicated space heating, makeup air, and spot heating can be combined with reductions in process equipment loads for the lowest total cost of ownership.

These multi-level savings extend beyond traditional energy cost retrofits, thus allowing industrial clients to maximize the lifecycle value of their facility and achieve attractive ROIs with payback periods of less than 2 years.

TOTAL COST OF OWNERSHIP COMPARISON

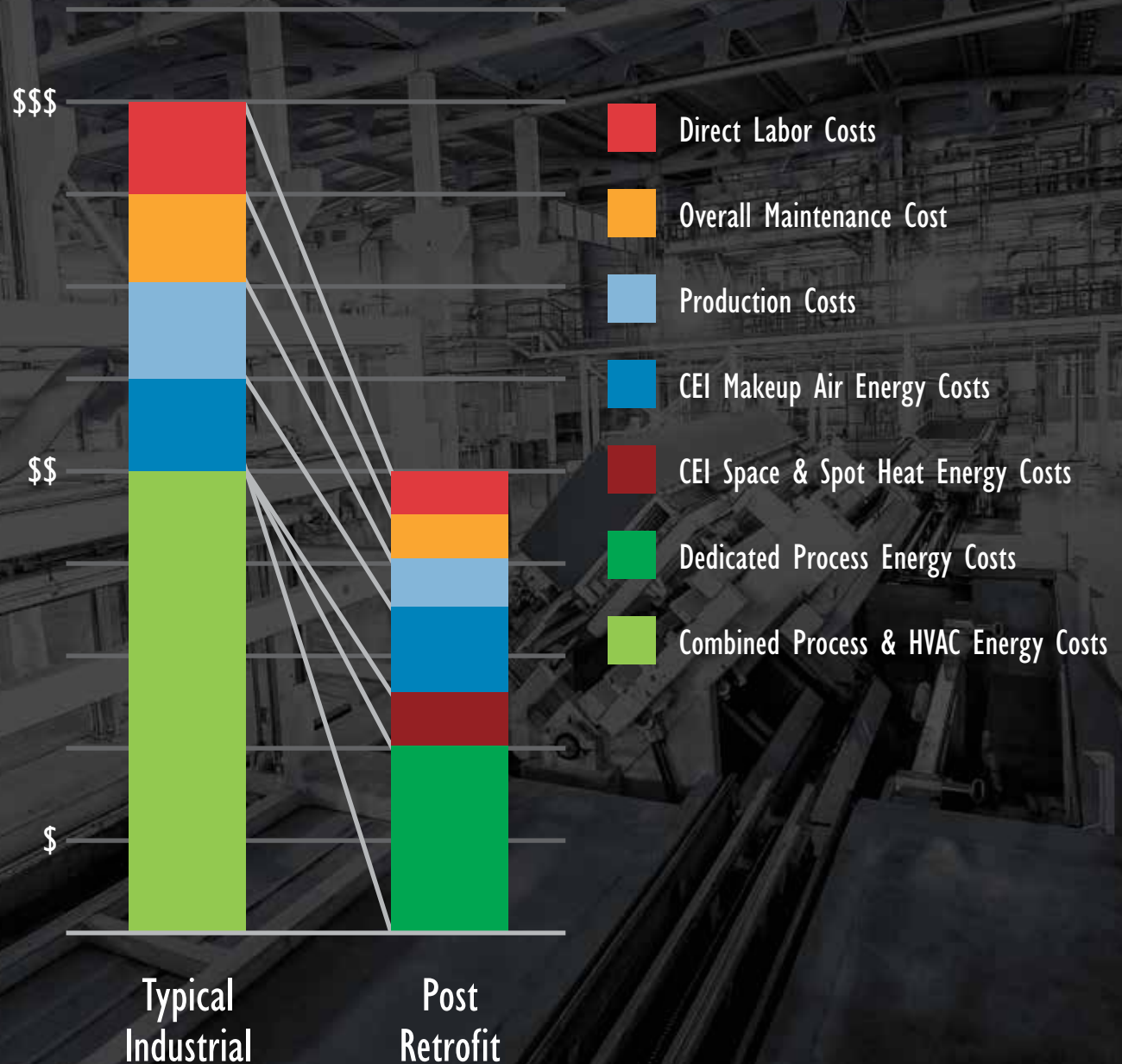



Why Cambridge Engineering

Simply put, a better HVAC retrofit process will simplify your world.

At Cambridge Engineering, we understand the challenges of retrofitting your outdated HVAC equipment. For over 50 years, we have worked with building owners and facility leaders to overcome the complex and unique requirements associated with retrofitting industrial facilities. Whether it's the high equipment cost, high energy cost, poor indoor air quality, or a corporate energy mandate, our line of commercial and industrial HTHV space heaters, makeup air units, and ventilation technologies will provide you with the best possible solutions.

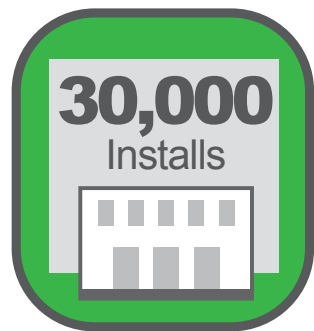

Over 30,000 successful Cambridge system installations



Over 400 commercial and industrial building studies that quantify savings



Over 2 billion square feet of space heated and ventilated with Cambridge equipment



Third-party building studies and white papers confirm 20% to 70% energy savings



A network of over 4,900 certified installation contractors



DOE TESTED



U.S. DEPARTMENT OF
ENERGY

Langendorf Supply Co., a leading distributor and supplier of HVAC equipment throughout the Midwest, wanted to reduce the operating costs and improve occupant comfort in their warehouse area. In collaboration with the DOE, the company identified upgrading their gas unit heaters to high-efficiency units as a potential solution. Langendorf's warehouse included several aisles of shelving racks that extended to the approximately 24 ft. high ceilings, as well as six loading docks across 42,000 sq. ft.

We work with Cambridge Engineering because they are easy to do business with. We specify our facility's needs, and they deliver the optimum solution with a quality product that fulfills our requirements.

—Cenergy Services



Some of our customers who have benefitted from Cambridge Engineering heating and ventilating retrofit solutions include:

General Motors

Continental Tire

Alcoa

Reynolds Aluminum

Nestlé

General Electric

Emerson

Our Process

1 Schedule an Introductory Meeting

- Analyze Facility's Current Systems
- Understand Facility's Challenges, Needs, and Goals
- Understand People, Process, and Production Needs

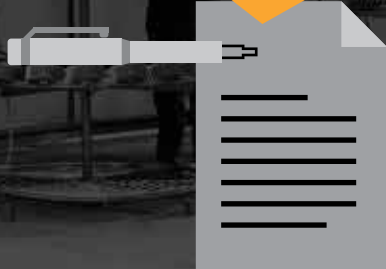

2 Complete an Industrial Retrofit Survey

3 Perform Feasibility Study

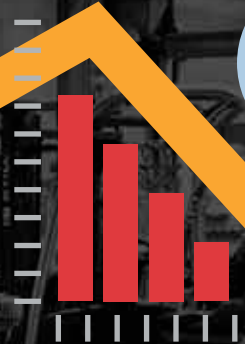

4 Determine Scope & Timing of Retrofit





Cambridge Engineering products are designed for simple installation, easy maintenance, and reliable operation.

They are available with certified and pre-engineered factory options and field-installed accessories. We manufacture products that heat and ventilate both commercial and industrial buildings and facilities. Following is a brief description of our M-Series, SA-Series, and S-Series that we provide for the industrial and commercial markets for retrofit opportunities.

All of our M-Series, S-Series, and SA-Series products have the following standard features:

- Proprietary high-performance type 304 stainless steel burner
- Patented low fire start technology that increases reliability and saves energy
- Low voltage hot surface igniter with patented Cambridge Low Fire Start provides dependable and energy-efficient gas ignition
- Closed cell, non-water absorbing insulation in the base of the unit eliminates condensation problems
- Units are tested fully assembled to minimize initial start-up time
- Engineering safety controls that include a high temperature limit switch, airflow switch, and a gas modulation control
- Service and gas valve leak test switches are provided for easy installation and service
- Stainless steel burner and flame rod reduce maintenance and extend service life
- High-quality polyester powder paint coating option
- Cambridge Engineering technical service department, with over 50 years of experience, can provide both onsite and telephone support

M-Series Specifications

Cambridge Engineering's M-Series Draw-Thru makeup air units provide fresh air ventilation to a facility, provide tempered air to replace the air that is mechanically exhausted, or address cold drafts from natural infiltration. Unit operation is typically electrically interlocked with mechanical exhaust fans, manually operated switches, programmable timers, or other process control systems. The discharge temperature of units with fixed discharge temperature controls is typically set 10°F to 20°F above the desired space temperature. The entering air thermostat acts as an economizer by deactivating burner operation during mild weather.

Performance Features:

- Cooling options: DX or chilled water coils and evaporative cooling
- Motorized inlet or discharge damper
- Inlet options that include single or dual rain hoods, V-bank filters sections, and high-efficiency filters
- Discharge options that include discharge duct, 3- and 4-way discharge diffusers and plenums
- Wide variety of control options
- Mounting curbs and stands
- External profile damper adjustment and built-in pressure gauge (manometer) reduces start-up time and ensures optimal burner performance
- Shielded and ventilated motor assembly extends motor life

BTU table

M110	425,000
M112	440,000
M115	550,000
M118	1,125,000
M120	1,395,000
M125	2,045,000
M130	2,475,000
M136	2,845,000
M140	5,345,000

CFM table

M110	1,800 to 3,250
M112	2,500 to 4,000
M115	4,000 to 7,500
M118	6,000 to 10,000
M120	10,000 to 17,000
M125	15,000 to 26,000
M130	20,000 to 36,000
M136	28,000 to 50,000
M140	40,000 to 75,000

M-Series Installation Flexibility:

Horizontal Outdoor Rooftop

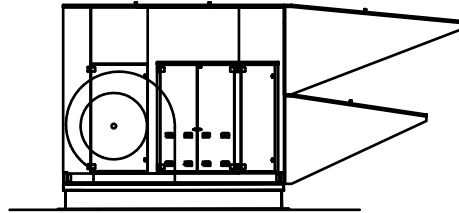

Horizontal Outdoor Thru Wall Pad Mount

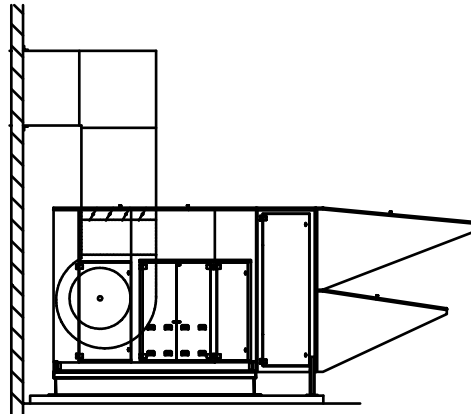

Horizontal Indoor Thru Wall

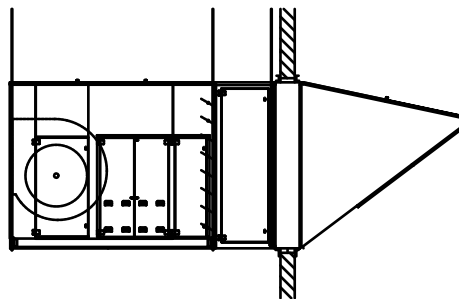

Vertical Indoor Thru Wall

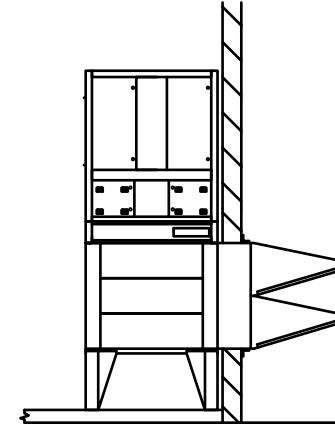

Vertical Outdoor Thru Wall

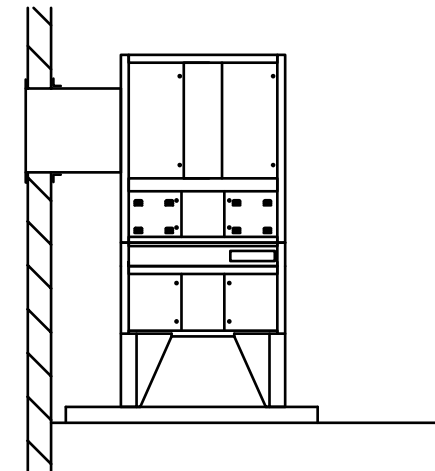

S-Series and SA-Series Specifications

Cambridge S-Series and SA-Series Blow-Thru® heaters are utilized to efficiently meet the space heating requirements of commercial and industrial buildings. The control system is typically designed to cycle the heaters on and off in response to the rise and fall of the space temperature. The heater will discharge air at the temperature selected (up to 160°F). The operating thermostat is typically located near the perimeter of the building in a location that is out of the direct path of the heated discharge air, insulated from cold surfaces, and shielded from cold drafts created by air infiltrating the building.

- High Temperature Heating & Ventilating technology (HTHV)
- 160°F Maximum rise and discharge temp provides energy efficiency
- 100% outside air provides ventilation and IAQ
- High 10:1 induction air mixing ratio minimizes stratification
- 5-year burner warranty
- Exceeds DOE's 90% High-Efficiency gas-fired technology standards
- Blow Thru Space Heating Technology provides maximum amount of BTUs per CFM
- Compact, lightweight, pre-piped and pre-wired to make installation and start-up easier
- Blow Thru design eliminates the time required during start-up for adjustment of burner profile damper
- Blow Thru design puts burner downstream of blower so motor and other critical components are located in the cool air stream for extended service life

SA-Series Specifications

BTU table

SA-250	250,000
SA-350	350,000

CFM table

SA-250	1,400
SA-350	3,500

SA-Series Installation Flexibility:

Horizontal Outdoor Rooftop

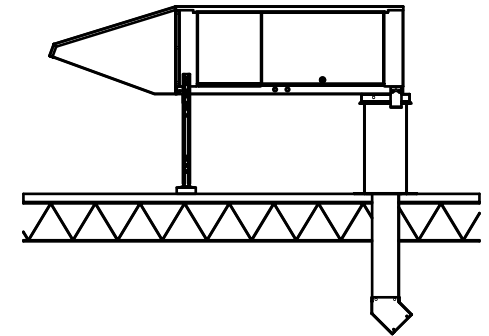

Horizontal Indoor Under Roof

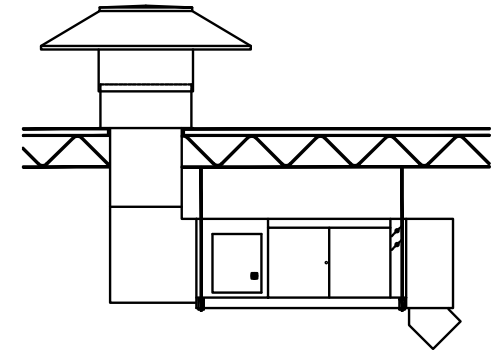

Horizontal Indoor Thru Wall

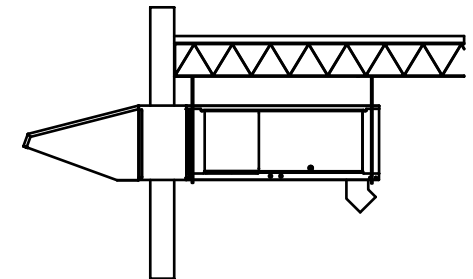

S-Series Specifications

BTU table

S-400	400,000
S-800	757,000
S950	950,000
SI200	1,200,000
SI600	1,499,000
SI850	1,850,000
S2200	2,200,000
S3200	3,107,000

CFM table

S-400	1,850
S-800	3,500
S950	4,400
SI200	5,555
SI600	6,940
SI850	8,565
S2200	10,185
S3200	14,380

S-Series Installation Flexibility:

Horizontal Outdoor Rooftop

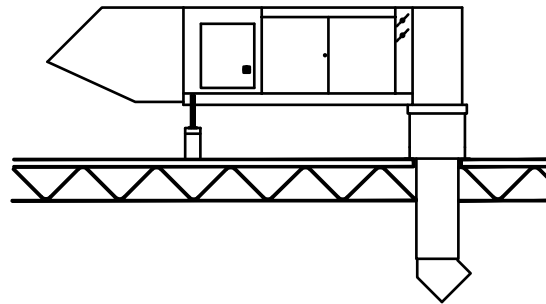

Horizontal Indoor Thru Wall

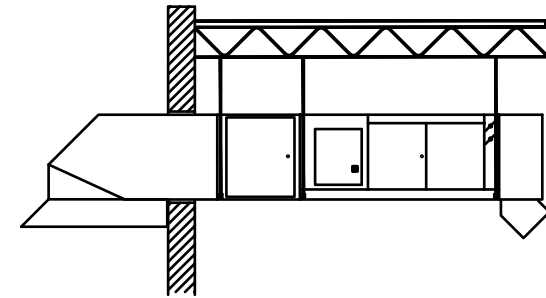

Horizontal Indoor Under Roof

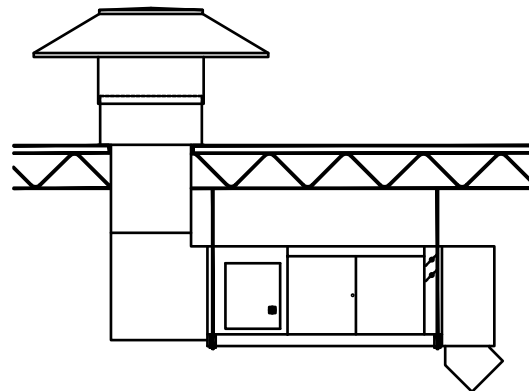

Vertical Outdoor Thru Wall

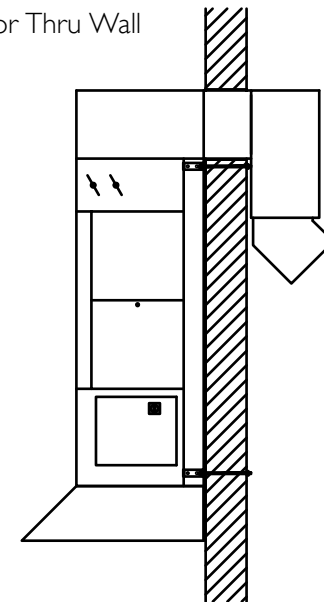



Copyright ©2017 Cambridge Engineering, Inc. All rights reserved.

Cambridge Engineering, Inc.
760 Long Rd Crossing Drive
Chesterfield, MO 63005
Phone: 800-899-1989
Fax: 636-449-0900
Email: clientcare@cambridge-eng.com
Web: www.cambridge-eng.com/irg